



WARNING: Please take the time to read through the ENTIRE instructions prior to starting any work. Not following the instructions will invalidate the warranty.

PRECAUTIONS:

1. Ensure normal safety precautions are taken when using tools, ladder and walking on roofs.
2. Do not cut any structural members in the house.
3. Install only in dry weather.

TOOLS REQUIRED:

- Power Drill
- Philips Screwdriver
- Caulk & Caulking Gun
- Ladder
- Electrical Tape
- 1/4" Masonry Bit (for tile roofs)
- Wire Staples

GABLE FAN KIT COMPONENTS:

- A.** Gable Fan with Cable
- B.** Solar Panel
- C.** (2) L-Brackets
- D.** (14) Wood Screws
- E.** (4) Self-Tapping Screws (L-bracket to panel)
- F.** (4) Machine Screws (for tile roofs)
- G.** (4) Anchors (for tile roofs)

NOTE: Additional Power Cable Available

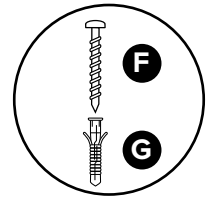
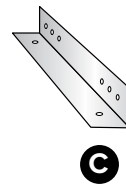
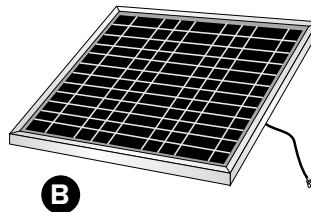
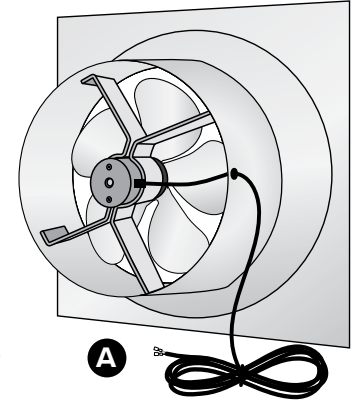

For Tile Installs Only

INSTALLATION POINTERS: When determining location of the solar panel, consider potential problems such as objects shading the unit during certain times of the day (southern exposure is recommended). To ensure proper ventilation, install the Gable Solar Fan so that it covers the entire gable opening.

STEP 1 Choose location to install the gable fan. The fan must be installed between studs in the gable area. For proper ventilation, the fan unit must cover the entire gable opening. If the gable opening is larger than the fan unit shroud, the excess opening must be blocked. **DO NOT CUT ANY WOOD FRAMING.** From inside the attic, position the gable fan (with the motor facing the attic) to the desired location and secure the shroud with the provided wood screws (D).

STEP 2 Locate area to install the solar panel on the roof where it will gather the most amount of sunlight (southern exposure is recommended). Attach the L-brackets (C) to the long sides of the solar panel with the self-tapping (E) screws into the pre-drilled holes on the panel frame. Attach solar panel to roof using the provided wood screws (D) - see Figure 2. Caulk around the wood screws to prevent leaks.

FOR TILE ROOFS: Pre-drill hole in tile to accommodate the anchors provided (G). Tap anchors into holes and secure L-bracket using provided screws (F) - see inset.

STEP 3 Use one of the following two options for routing the power cable from the fan to the solar panel:

OPTION 1: Route the power cable from the fan unit through the gable vent and along the outside of the house up to the roof.

OPTION 2: Drill a small hole next to the solar panel on the roof. Route the power cable from the fan unit through the attic and up through the hole. Caulk around hole to prevent leaking.

STEP 4 Connect the power cable from the fan unit to the power cable from the solar panel. Connect the black wire to the black wire and the red wire to the red wire. If the power cables do not reach, a power adapter cable is available. If wire connections are located outside of the attic space, wrap the connections with electrical tape to prevent water infiltration. Secure any loose wires using wire staples (not provided).

NOTE - Please make sure the male connector is centered before joining connectors. Male connector must be inserted into female connector correctly as shown.

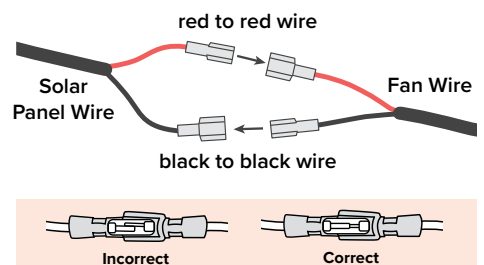
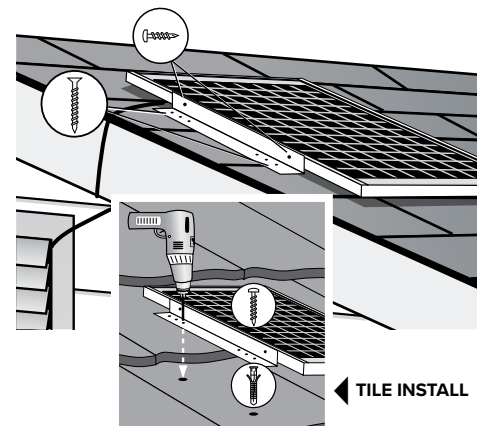
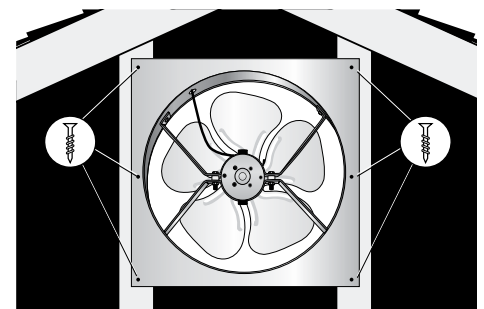



Solar Attic Fan Limited Lifetime Warranty

Natural Light Energy System (hereinafter NLES) warrants any solar attic fan manufactured by NLES to be free from defects in materials and workmanship to the original residential purchaser (hereinafter CONSUMER) from the date of purchase. All aspects of the Warranty are subject to the following limitations, terms and conditions.

1. DURATION OF WARRANTY

If a NLES solar attic fan (hereinafter "Equipment") is determined to have a defect in material or workmanship, NLES will, at its sole discretion, repair or replace the defective part at NO CHARGE to the CONSUMER, (excluding labor, and applicable shipping and handling costs) for the duration of the CONSUMER'S ownership of the original equipment (hereinafter "LIFETIME").

2. LIMITATIONS OF COVERAGE

This Warranty extends only to the CONSUMER for damage resulting from defects in materials and workmanship, it does not extend to damage caused by the CONSUMER'S neglect or abuse, or by accident, to damage caused by wind, hail or abnormal weather conditions, or to damage caused by acts of God, civil insurrection or extraordinary circumstances which are beyond the control of NLES.

NLES shall not be liable for any direct or indirect damage resulting from the use of the Equipment, and in no event shall the extent of the Warranty coverage exceed the purchase price of the Equipment.

NLES assumes no liability for the determination of the proper equipment necessary to meet a CONSUMER'S requirements, nor does it authorize others to assume such obligations on its behalf.

3. MISCELLANEOUS

In order to be considered for validation, all claims for Warranty coverage must be accompanied by a copy of the purchase agreement indicating the date of initial installation, NLES reserves the right to inspect the solar attic fan prior to honoring any Warranty claim.

This Warranty gives you specific legal rights, and you may have other rights which may vary from state to state. Any and all inquiries or claims under this Warranty must be submitted in writing to **Natural Light Energy Systems, Attn: Warranty Department, 10821 N. 23rd Avenue, Phoenix, AZ 85029** or by e-mail to info@nltubular.com.



To register your Solar Attic Fan, please visit
www.solaratticfan.com/customer-service/warranty-registration/



REGISTER NOW